

## Anbauanleitung Seilwindenanbausatz Mitsubishi L 200 Bj.2002 aufwärts

Best.-Nr.: 16 – 3780

AL: 1131 - 00



Hier sehen sie den fertig montierten Seilwindenanbausatz.  
Bevor sie mit der Montage beginnen lesen sie bitte diese Anleitung  
und das Benutzerhandbuch der Seilwinde gut durch.

### Achtung:

Bei Fahrten im öffentlichen Straßenverkehr muß das Rollenseilfenster  
mit der Kunststoffabdeckung Best.nr.: 15 – 899 abgedeckt werden.

# Stückliste

## Seilwindenanbausatz Mitsubishi L 200 einschl. 2005

Best.nr.: 16 – 3780

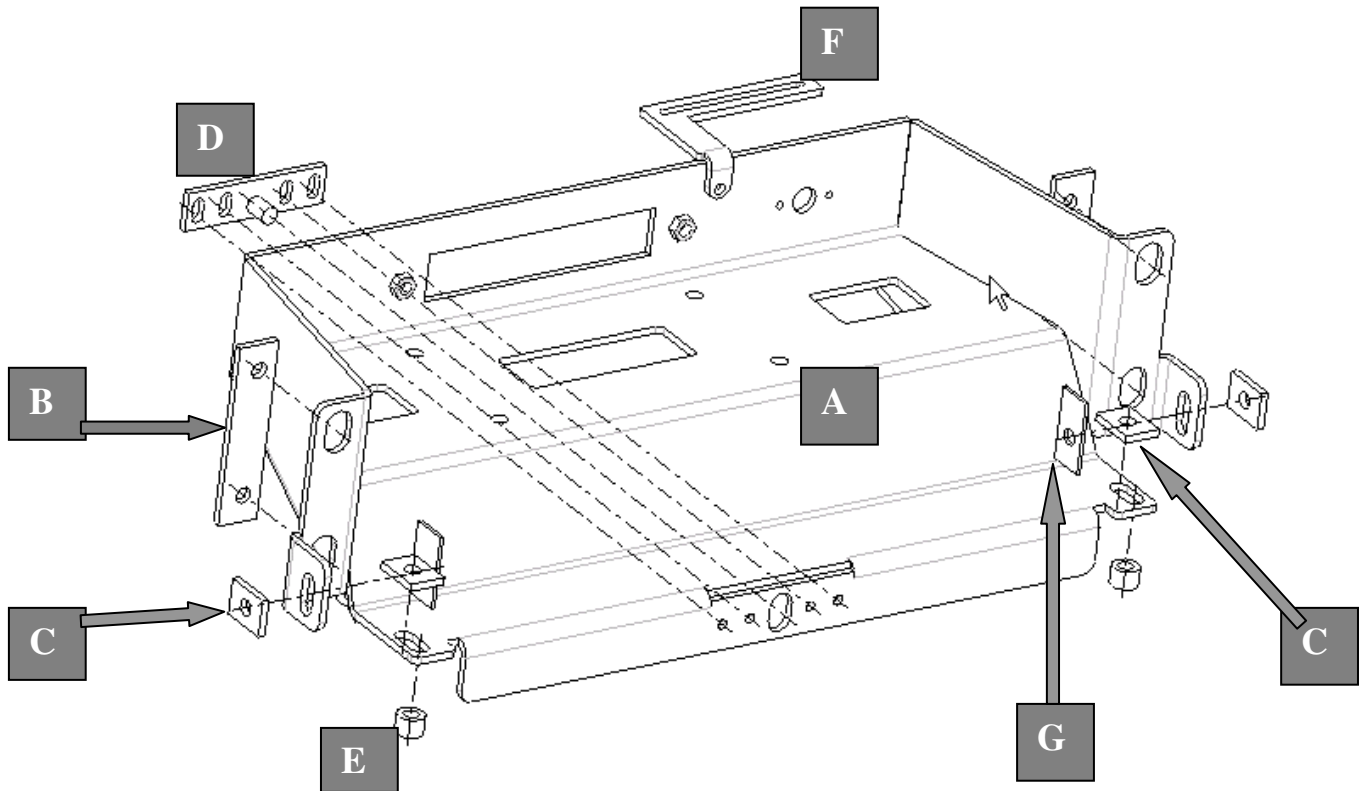

1 x Seilwindenplatte ( A )	2 x Schraube M 12 x 80
2 x Verstärkungsblech ( B )	2 x U- Scheibe M 12 x 30
4 x Distanzplatte bzw. Verstärkungsplatte ( C )	2 x U – Scheibe M 12
1 x Zentrierung ( D )	2 x Federring M 12
2 x Distanzhülse ( E )	2 x Mutter M 12
1 x Schaltkastenhalter ( F )	4 x Schraube M 10 x 1,25 x 40
2 x Distanzplatte ( G ) nur für Modelle bis 2005	2 x Schraube M 10 x 1,25 x 50
<b>1 x Steckdose 1 – 39744</b>	2 x Schraube M 10 x 25
<b>1 x Kunststoffabdeckung 15 – 899</b>	8 x U – Scheibe M 10
1 x Gutachten	8 x Federring M 10
1 x Anbauanleitung AL 1131	4 x Schraube M 8 x 16
	4 x U – Scheibe M 8
	4 x Federring M 8
	4 x Schraube M 6 x 20
	4 x U-Scheibe M 6 x 20
	4 x Federring M 6
	4 x Mutter M 6
	2 x Schraube M 5 x 25
	4 x U – Scheibe M 5
	2 x Federring M5
	2 x Mutter M 5



- Demontieren sie den Kühlergrill und den Stoßfänger.

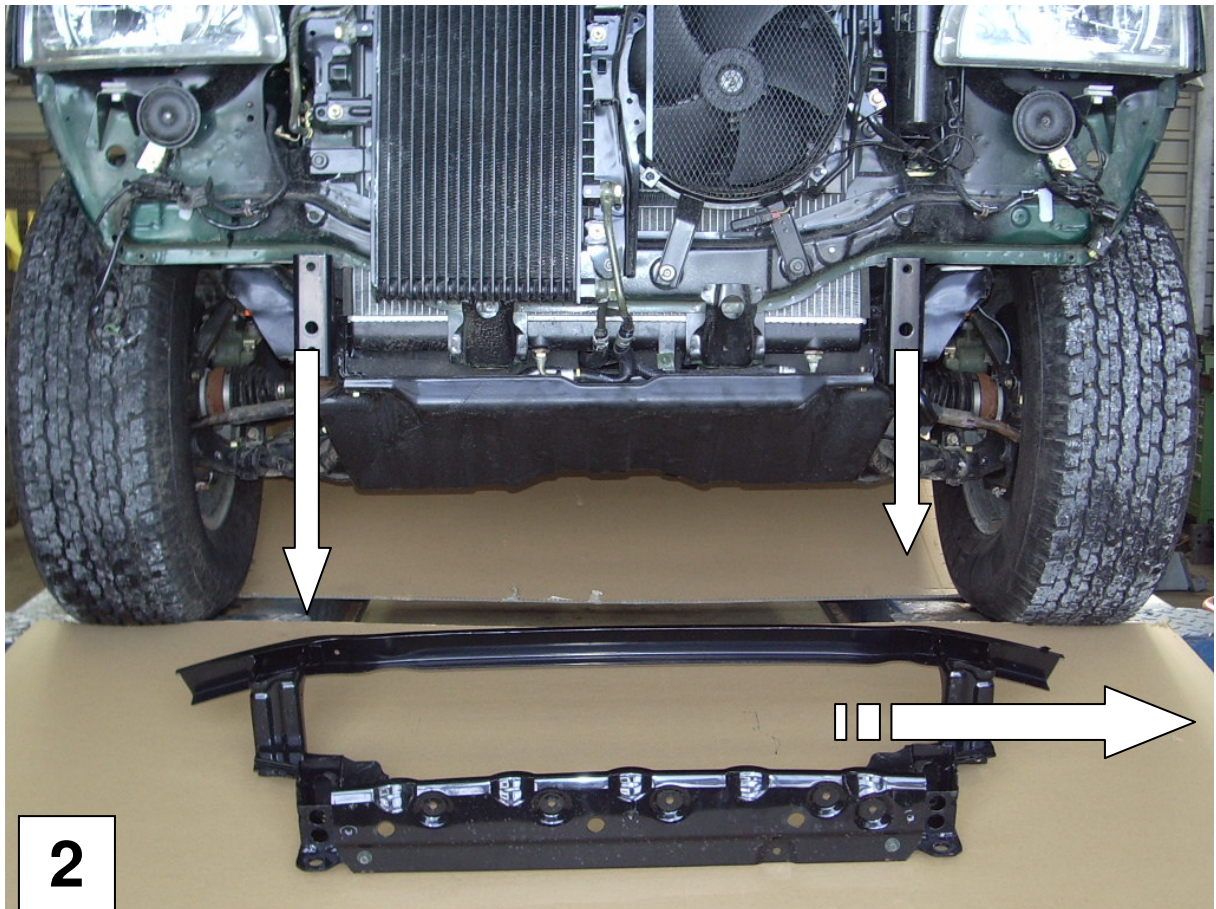

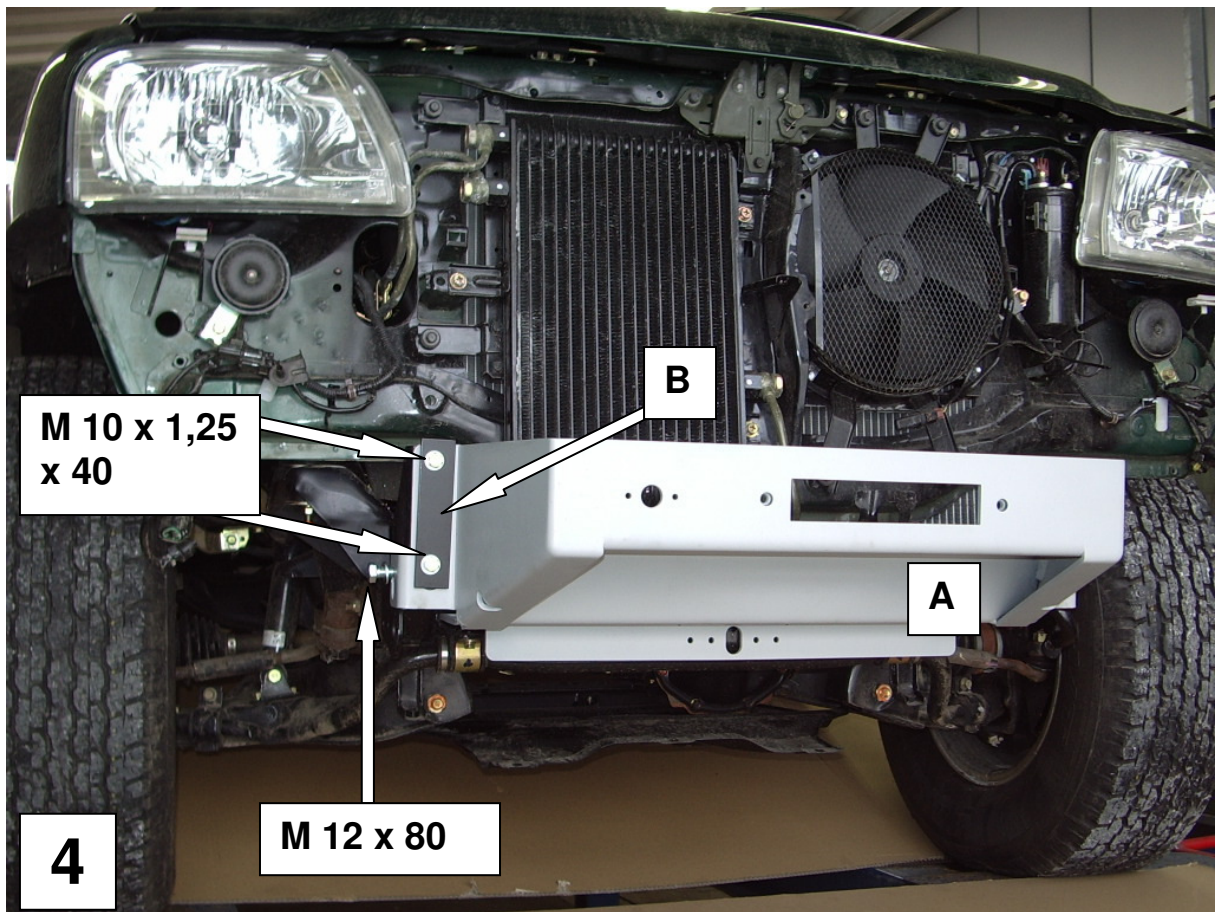

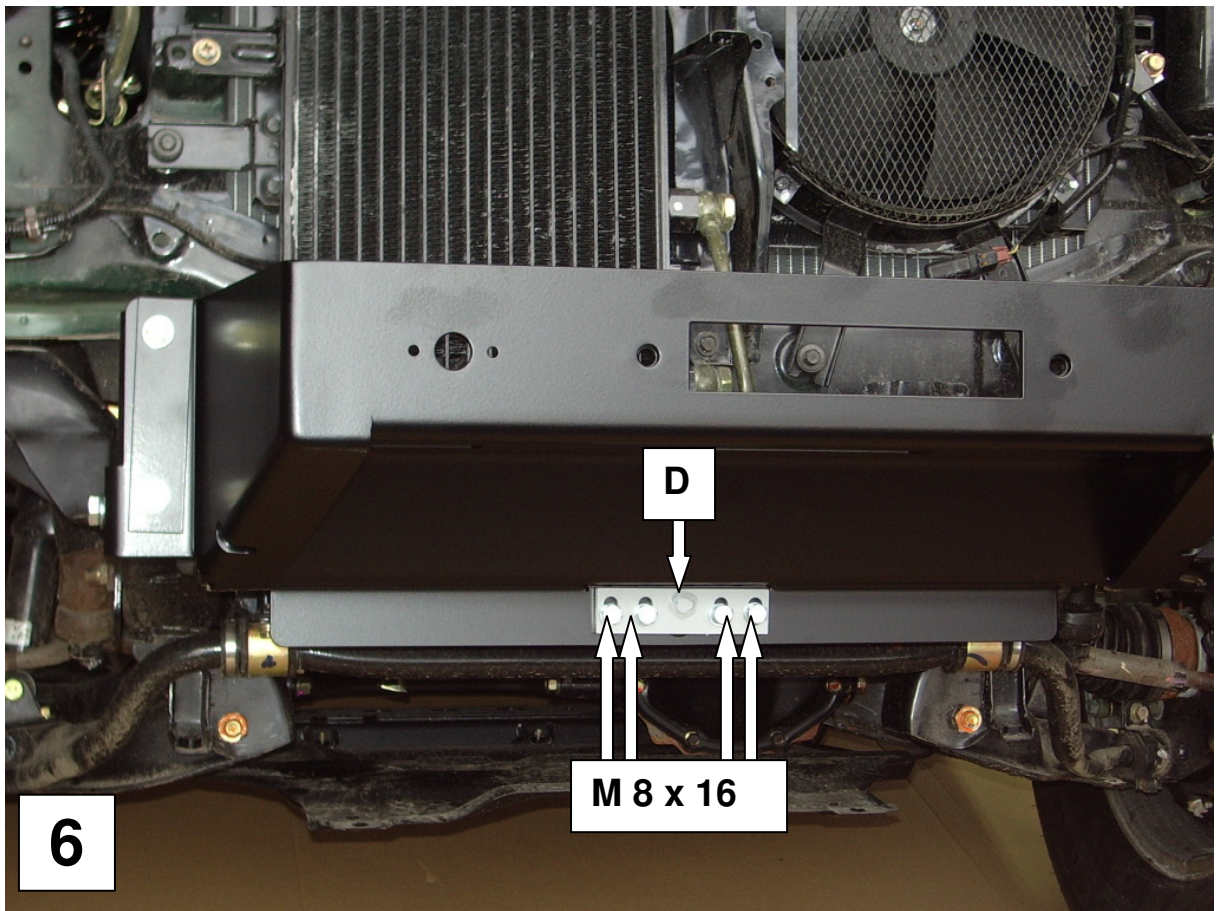
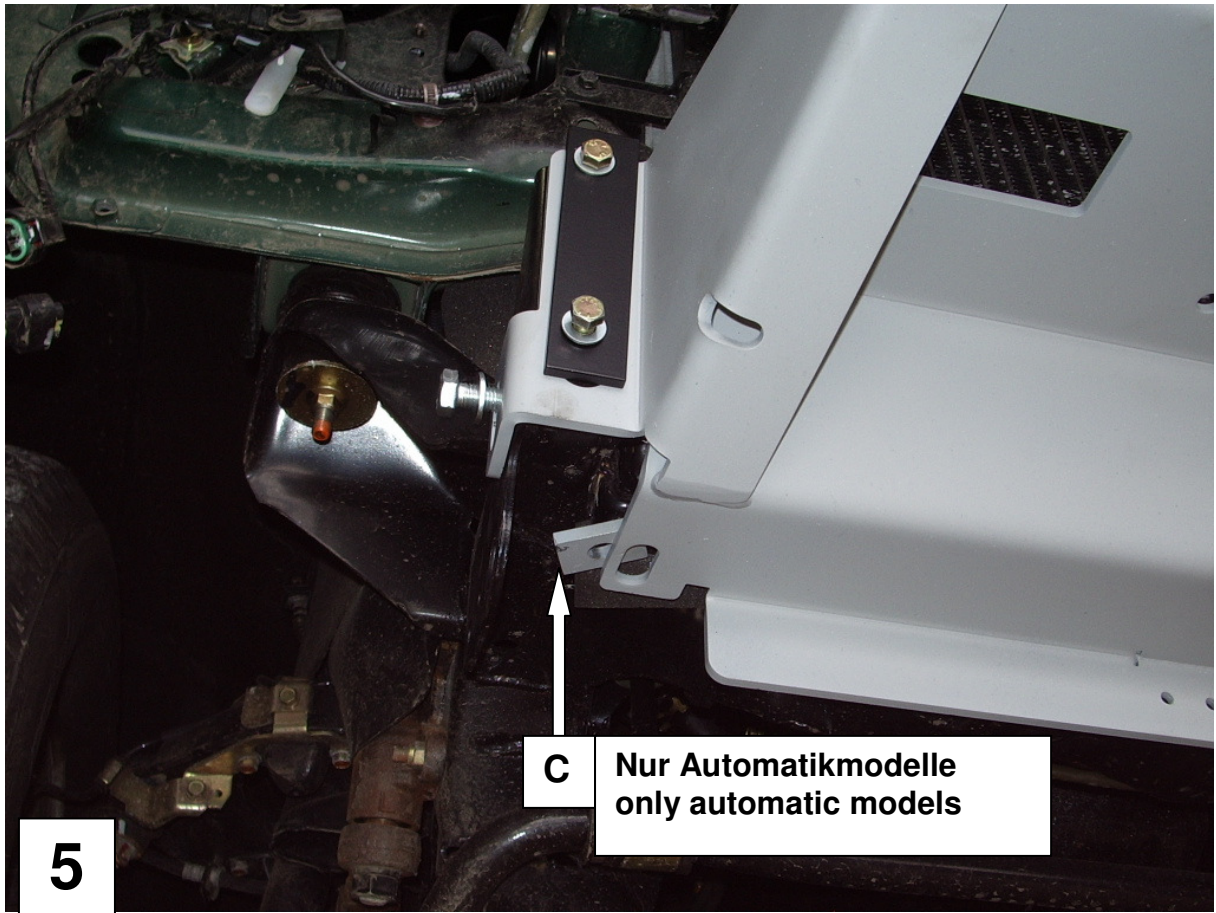

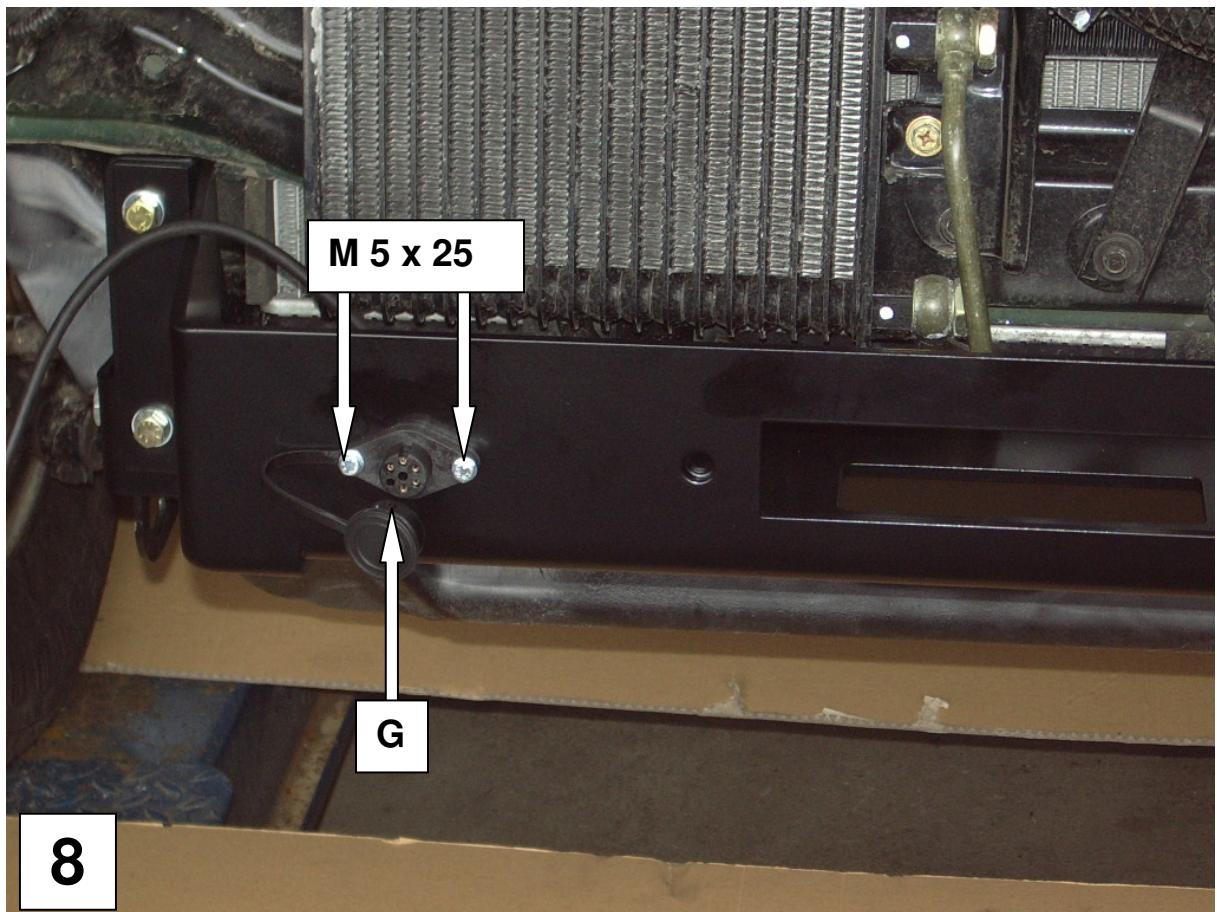
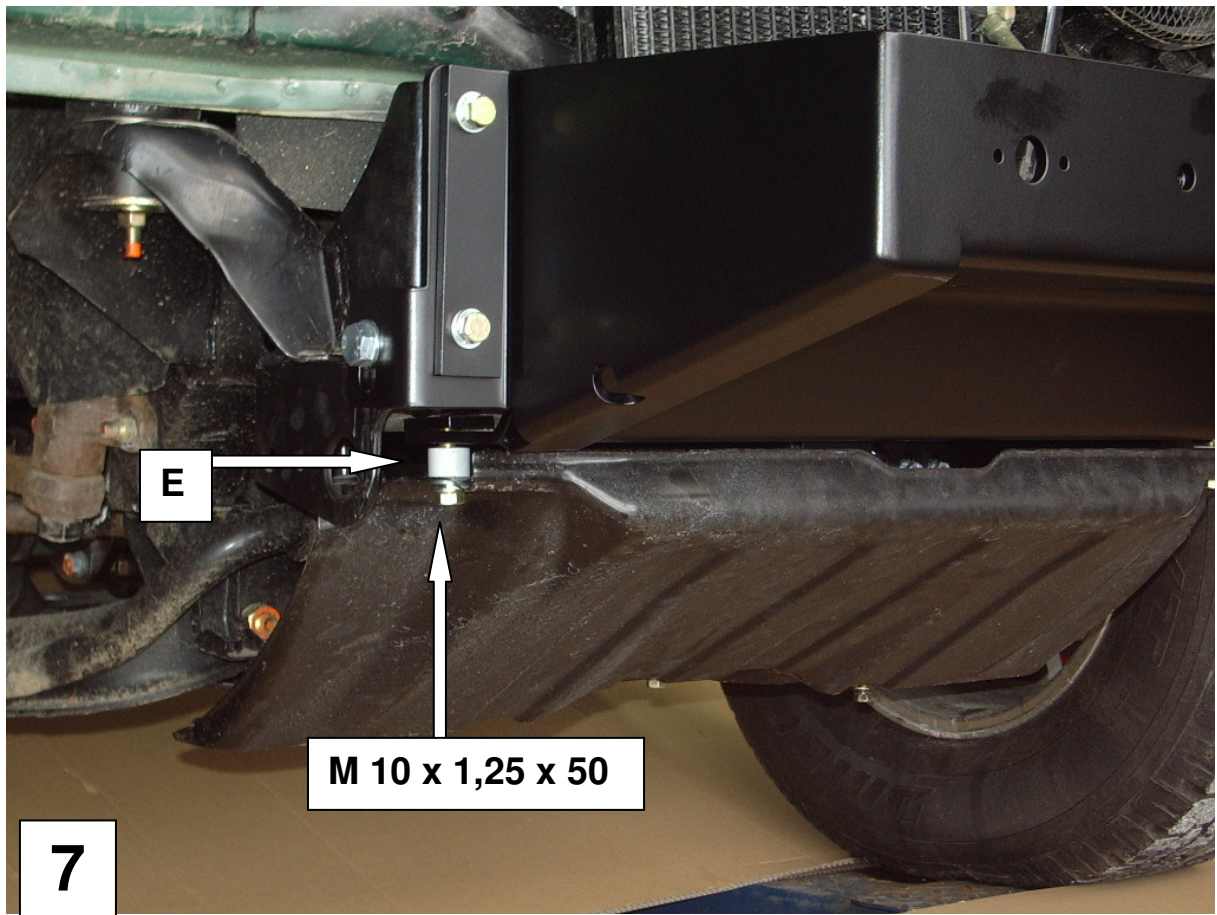

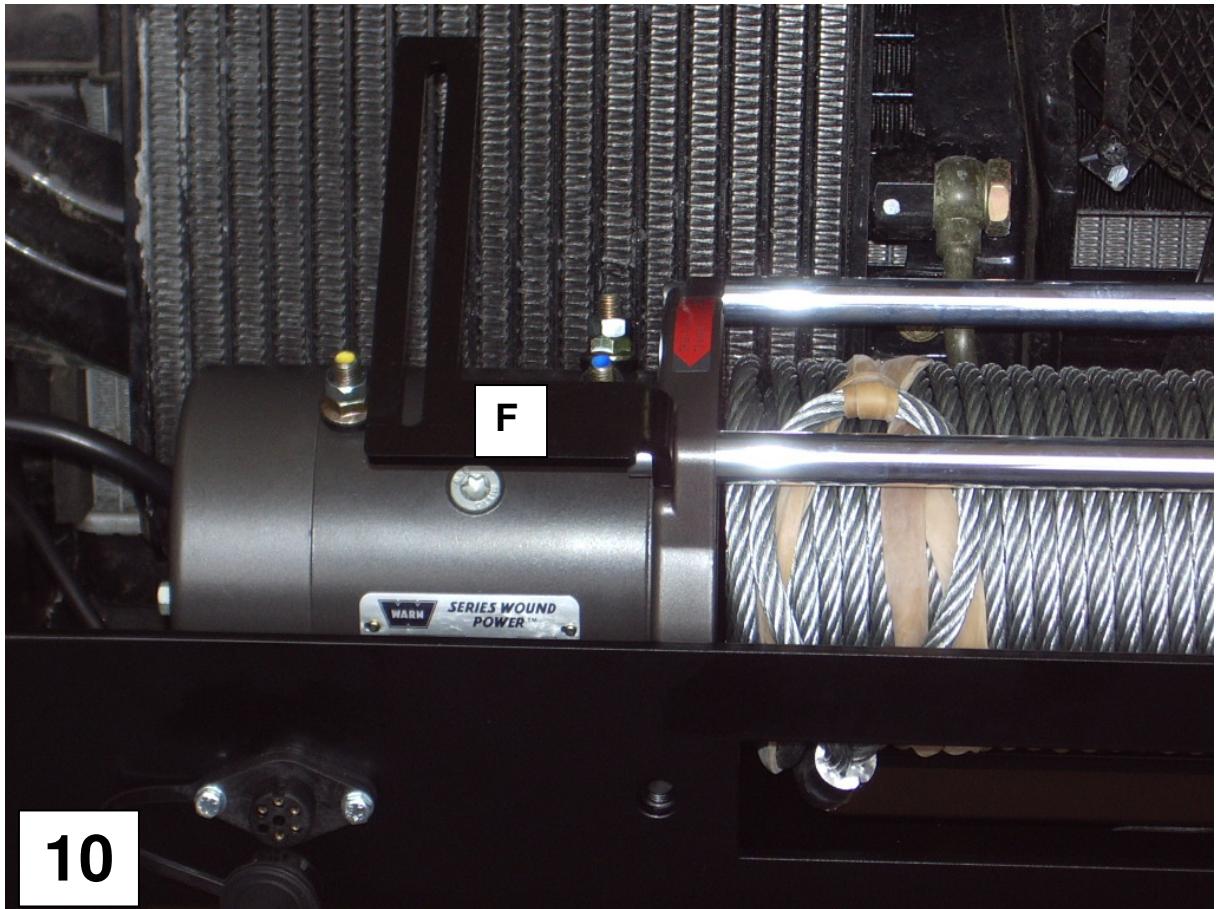
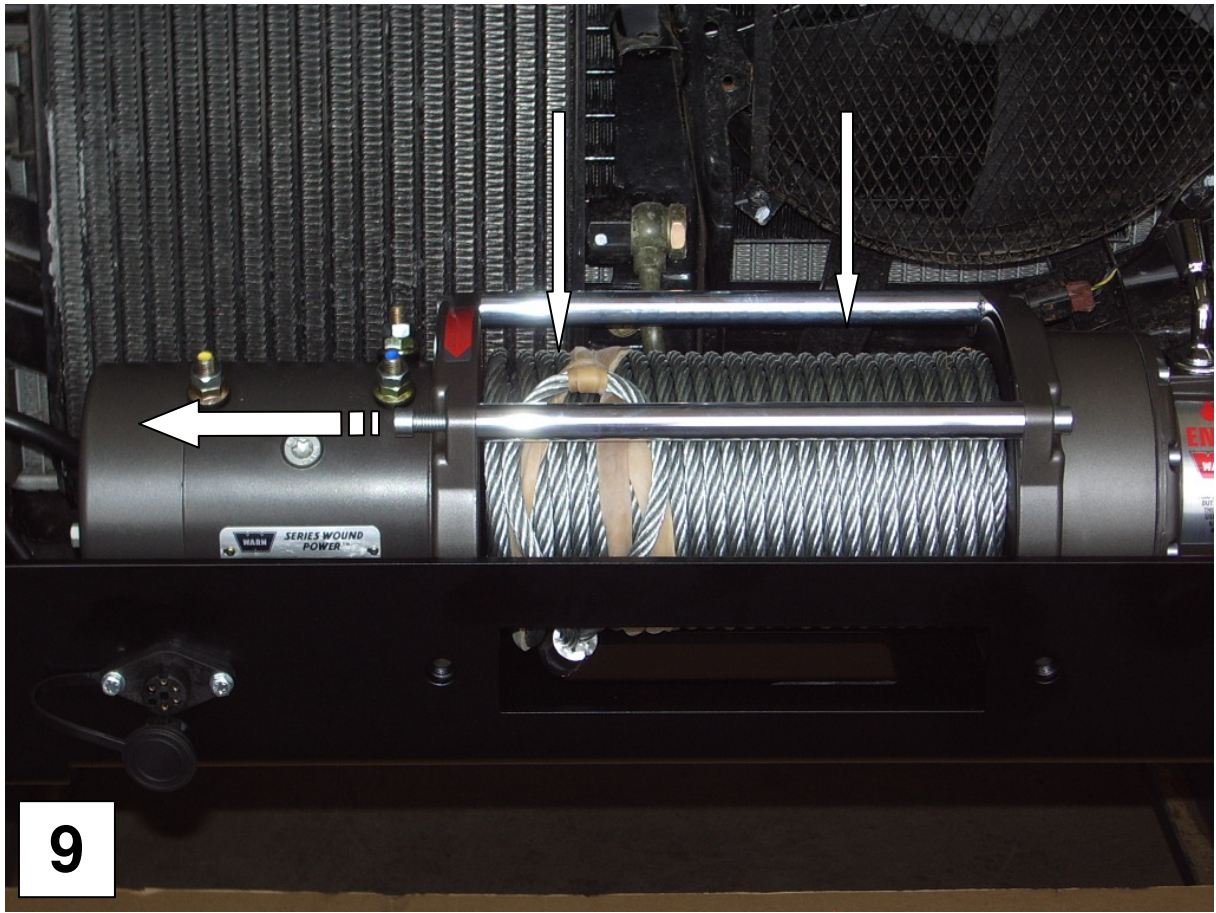

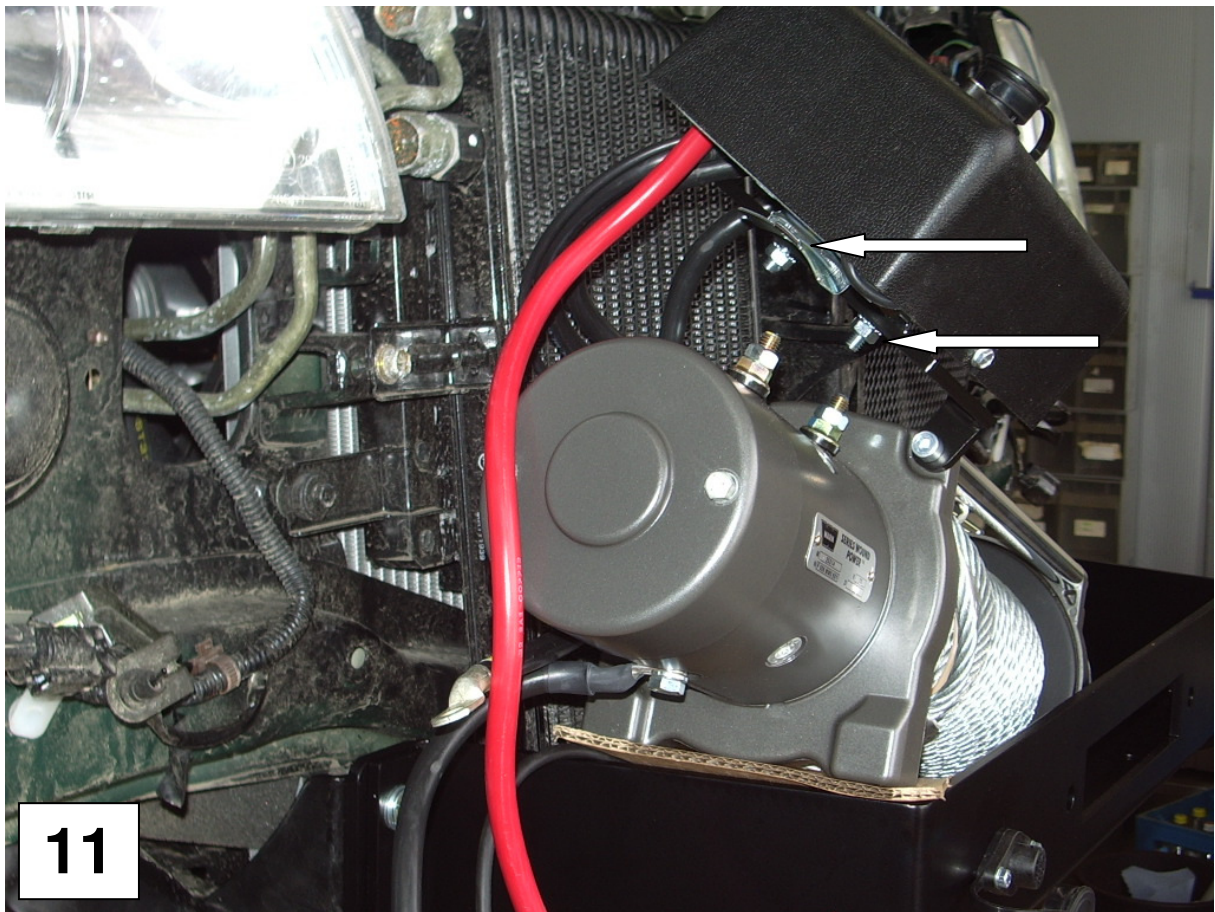

11

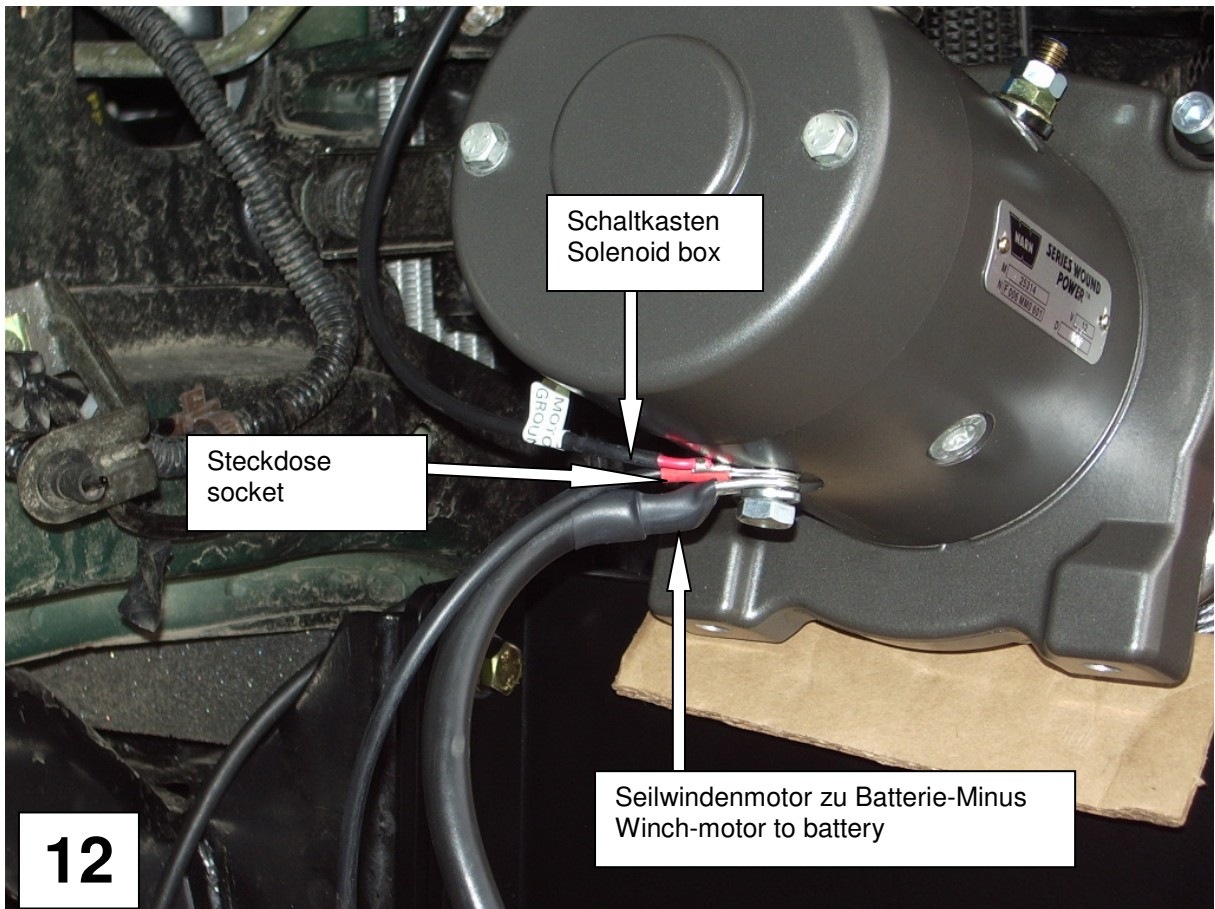

12



